

WOOD PELLETS ONLY SILO DESIGN WITH FILLING PIPES, 1 HEATING CIRCUIT, COMPLETE REGULATION AND REMOTE I-CLOUD VISUALIZATION, FULLY MONITORED AND REGULATED APARTMENT HOUSE, GRODNO-DUBNITSA, BELARUS

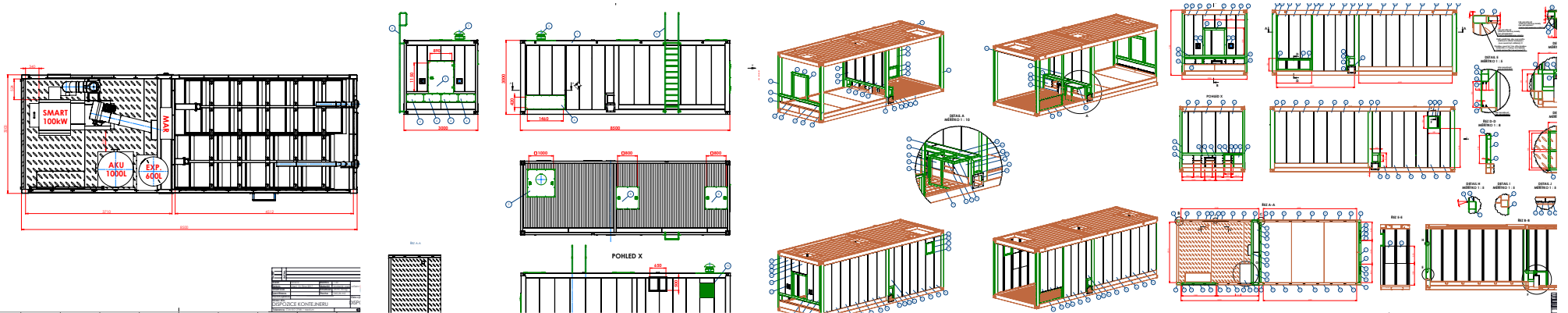

SMART REFERENCE LIST | SMART MICRO CABIN 100 KW

WOOD PELLETS ONLY SILO DESIGN WITH FILLING PIPES, 1 HEATING CIRCUIT, COMPLETE REGULATION AND REMOTE Icloud VISUALIZATION, FULLY MONITORED AND REGULATED APARTMENT HOUSE, GRODNO-DUBNITSA, BELARUS



SMART REFERENCE LIST | SMART MICRO CABIN 100 KW

WOOD PELLETS ONLY SILO DESIGN WITH FILLING PIPES, 1 HEATING CIRCUIT, COMPLETE REGULATION AND REMOTE ICloud VISUALIZATION, FULLY MONITORED AND REGULATED APARTMENT HOUSE, GRODNO-DUBNITSA, BELARUS



SMART REFERENCE LIST | SMART MICRO CABIN 100 KW

WOOD PELLETS ONLY SILO DESIGN WITH FILLING PIPES, 1 HEATING CIRCUIT, COMPLETE REGULATION AND REMOTE ICloud VISUALIZATION, FULLY MONITORED AND REGULATED APARTMENT HOUSE, GRODNO-DUBNITSA, BELARUS



SMART REFERENCE LIST | SMART MICRO CABIN 100 KW

WOOD PELLETS ONLY SILO DESIGN WITH FILLING PIPES, 1 HEATING CIRCUIT, COMPLETE REGULATION AND REMOTE ICloud VISUALIZATION, FULLY MONITORED AND REGULATED APARTMENT HOUSE, GRODNO-DUBNITSA, BELARUS





SMART REFERENCE LIST | SMART MICRO CABIN 100 KW

WOOD PELLETS ONLY SILO DESIGN WITH FILLING PIPES, 1 HEATING CIRCUIT, COMPLETE REGULATION AND REMOTE ICloud VISUALIZATION, FULLY MONITORED AND REGULATED APARTMENT HOUSE, GRODNO-DUBNITSA, BELARUS



3,2 x 3 x 13,5 m SMART MAGNUM CABIN WITH SMART 500 kW BIOMASS BOILER, VISSMANN VITOPLEX 200 550 kW OIL BACK UP BOILER, ZEPPELIN CAT EL. GENERATOR 20 kW_e, 4000 l OF ACCUMULATION TANK STORAGE, 1 COMPLETELY CONTROLLED HEATING CIRCUIT, 2 x 18 m CHIMNEY, 2 X MULTI-FUEL CONVEYORS SET CONNECTED TO AN EXISTING CONCRETE SILO WITH MOVING SILO ROOF, NORWEGIAN ARMY BUILDINGS HEATING, NORDKISA-OSLO AIRPORT, NORWAY

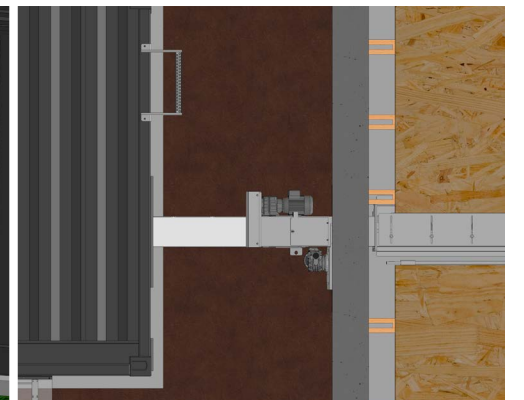
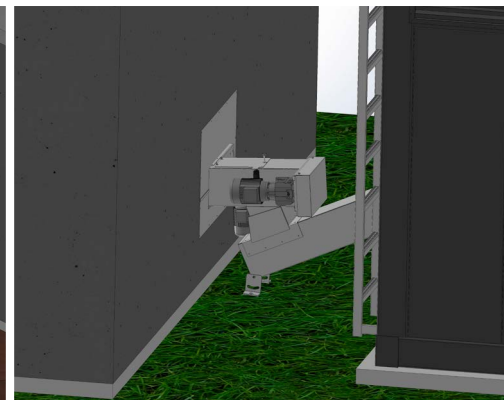
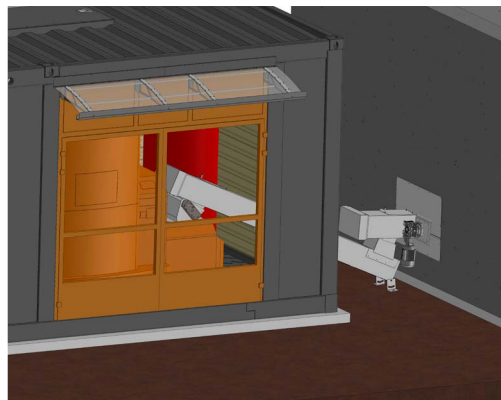
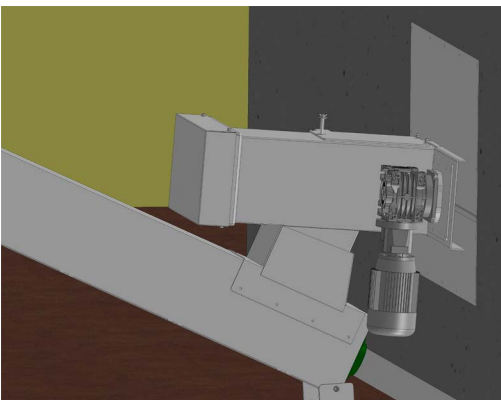
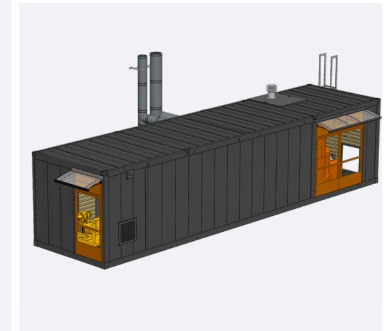
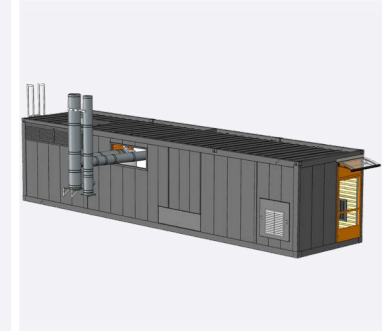
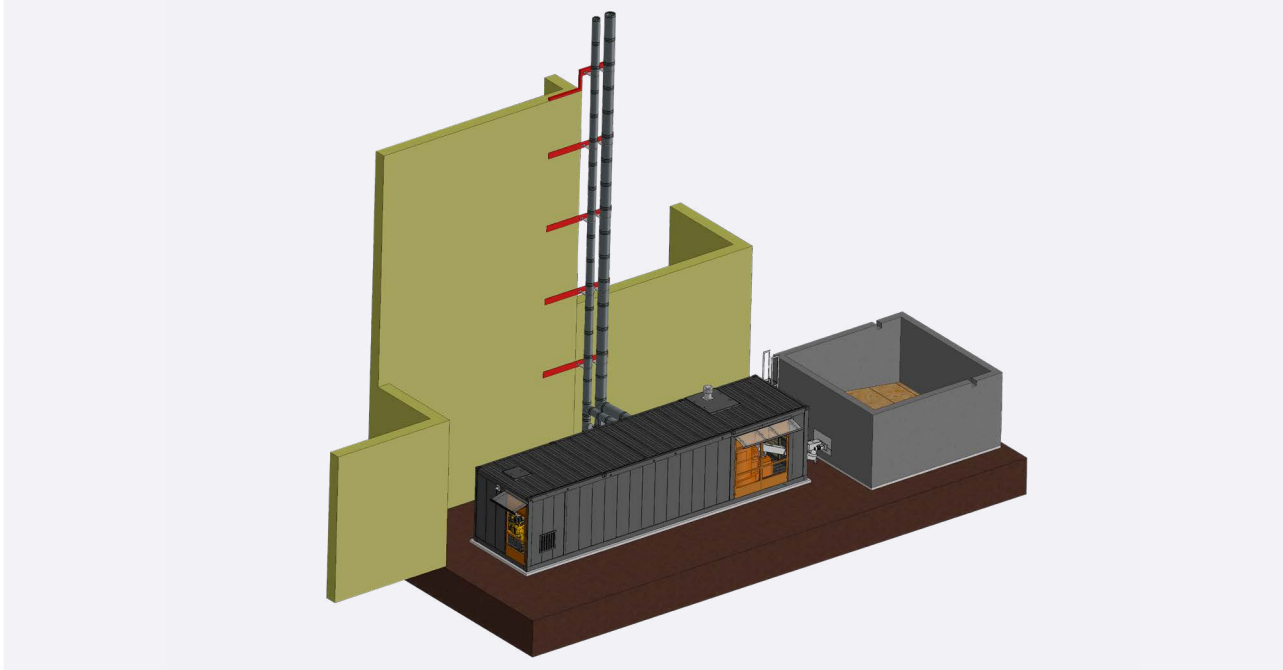
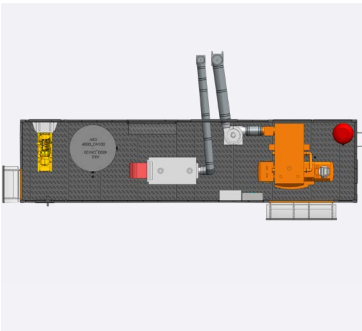
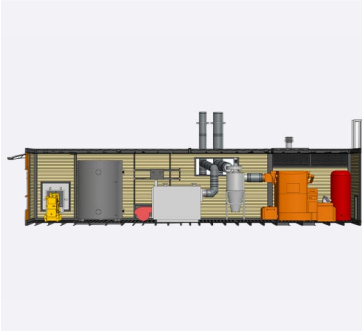

3,2 x 3 x 13,5 m SMART MAGNUM CABIN WITH SMART 500 kW BIOMASS BOILER, VISSMANN VITOPLEX 200 550 kW OIL BACK UP BOILER, ZEPPELIN CAT EL. GENERATOR 20 kW_e, 4000 l OF ACCUMULATION TANK STORAGE, 1 COMPLETELY CONTROLLED HEATING CIRCUIT, 2 x 18 m CHIMNEY, 2 X MULTI-FUEL CONVEYORS SET CONNECTED TO AN EXISTING CONCRETE SILO WITH MOVING SILO ROOF, NORWEGIAN ARMY BUILDINGS HEATING, NORDKISA-OSLO AIRPORT, NORWAY

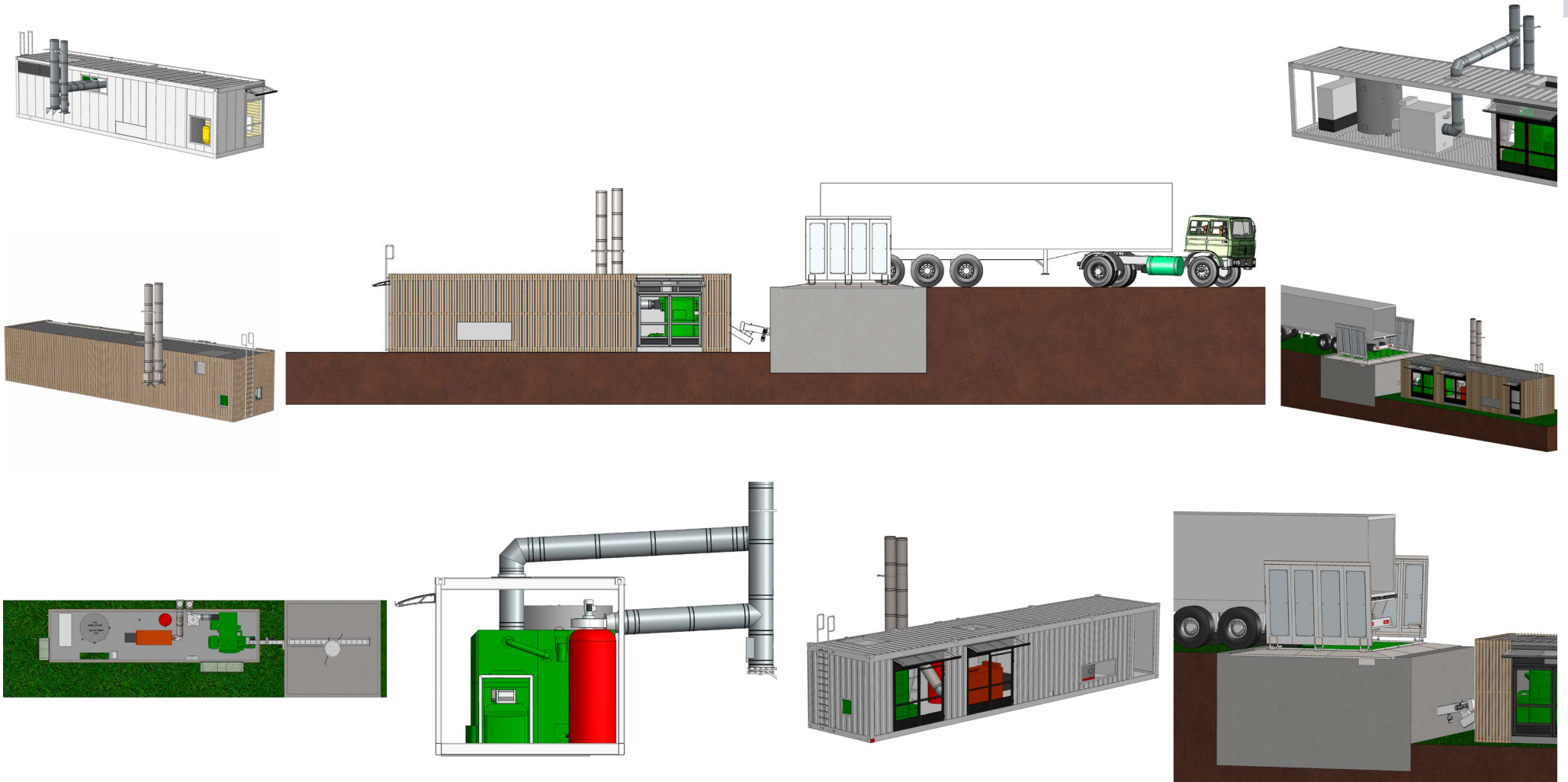

3,2 x 3 x 13,5 m SMART MAGNUM CABIN WITH SMART 500 kW BIOMASS BOILER, VISSMANN VITOPLEX 200 550 kW OIL BACK UP BOILER, ZEPPELIN CAT EL. GENERATOR 20 kW_e, 4000 l OF ACCUMULATION TANK STORAGE, 1 COMPLETELY CONTROLLED HEATING CIRCUIT, 2 x 18 m CHIMNEY, 2 X MULTI-FUEL CONVEYORS SET CONNECTED TO AN EXISTING CONCRETE SILO WITH MOVING SILO ROOF, NORWEGIAN ARMY BUILDINGS HEATING, NORDKISA-OSLO AIRPORT, NORWAY

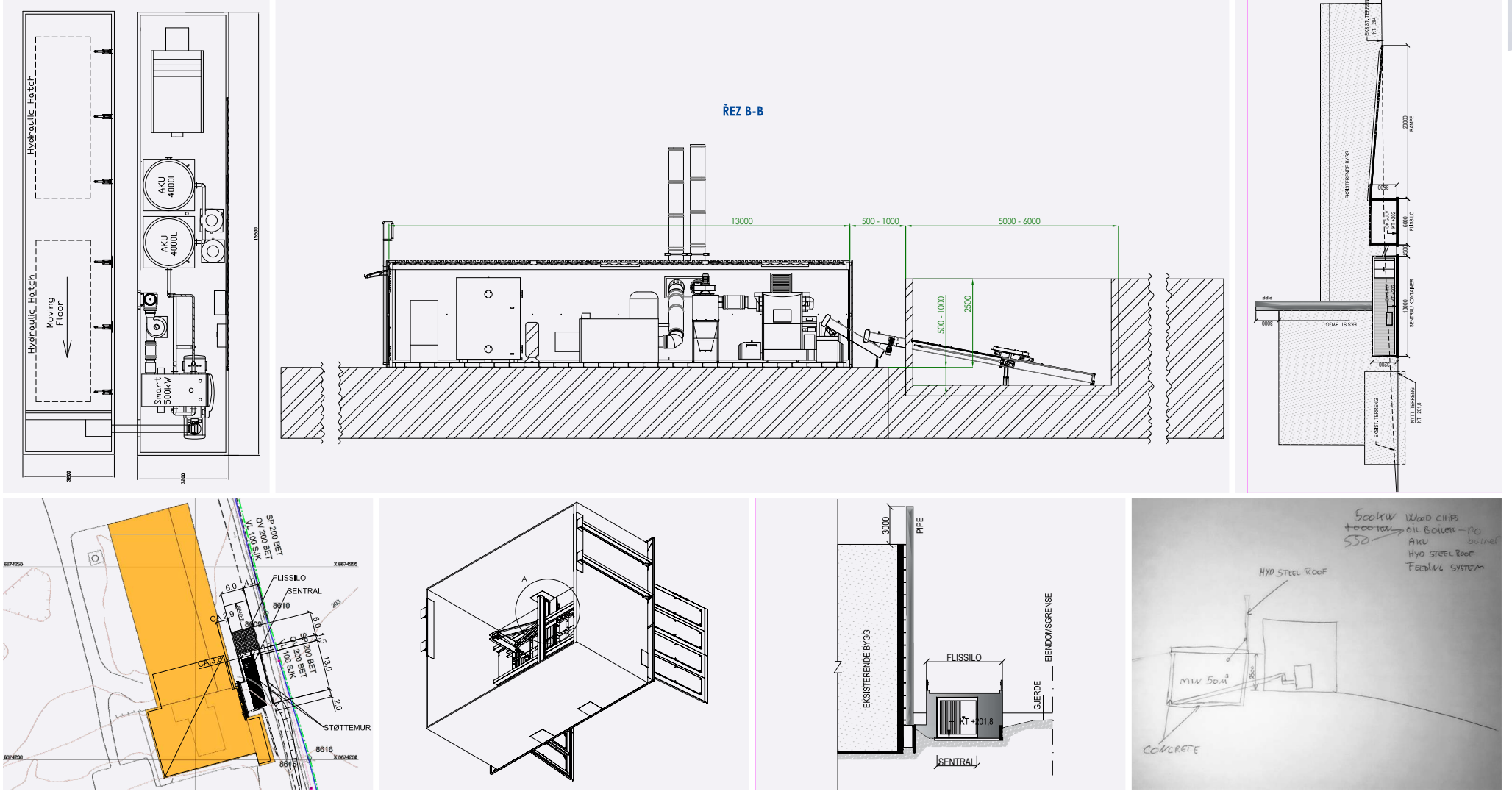

3,2 x 3 x 13,5 m SMART MAGNUM CABIN WITH SMART 500 kW BIOMASS BOILER, VISSMANN VITOPLEX 200 550 kW OIL BACK UP BOILER, ZEPPELIN CAT EL. GENERATOR 20 kW_e, 4000 l OF ACCUMULATION TANK STORAGE, 1 COMPLETELY CONTROLLED HEATING CIRCUIT, 2 x 18 m CHIMNEY, 2 X MULTI-FUEL CONVEYORS SET CONNECTED TO AN EXISTING CONCRETE SILO WITH MOVING SILO ROOF, NORWEGIAN ARMY BUILDINGS HEATING, NORDKISA-OSLO AIRPORT, NORWAY



3,2 x 3 x 13,5 m SMART MAGNUM CABIN WITH SMART 500 kW BIOMASS BOILER, VISSMANN VITOPLEX 200 550 kW OIL BACK UP BOILER, ZEPPELIN CAT EL. GENERATOR 20 kW_e, 4000 l OF ACCUMULATION TANK STORAGE, 1 COMPLETELY CONTROLLED HEATING CIRCUIT, 2 x 18 m CHIMNEY, 2 X MULTI-FUEL CONVEYORS SET CONNECTED TO AN EXISTING CONCRETE SILO WITH MOVING SILO ROOF, NORWEGIAN ARMY BUILDINGS HEATING, NORDKISA-OSLO AIRPORT, NORWAY

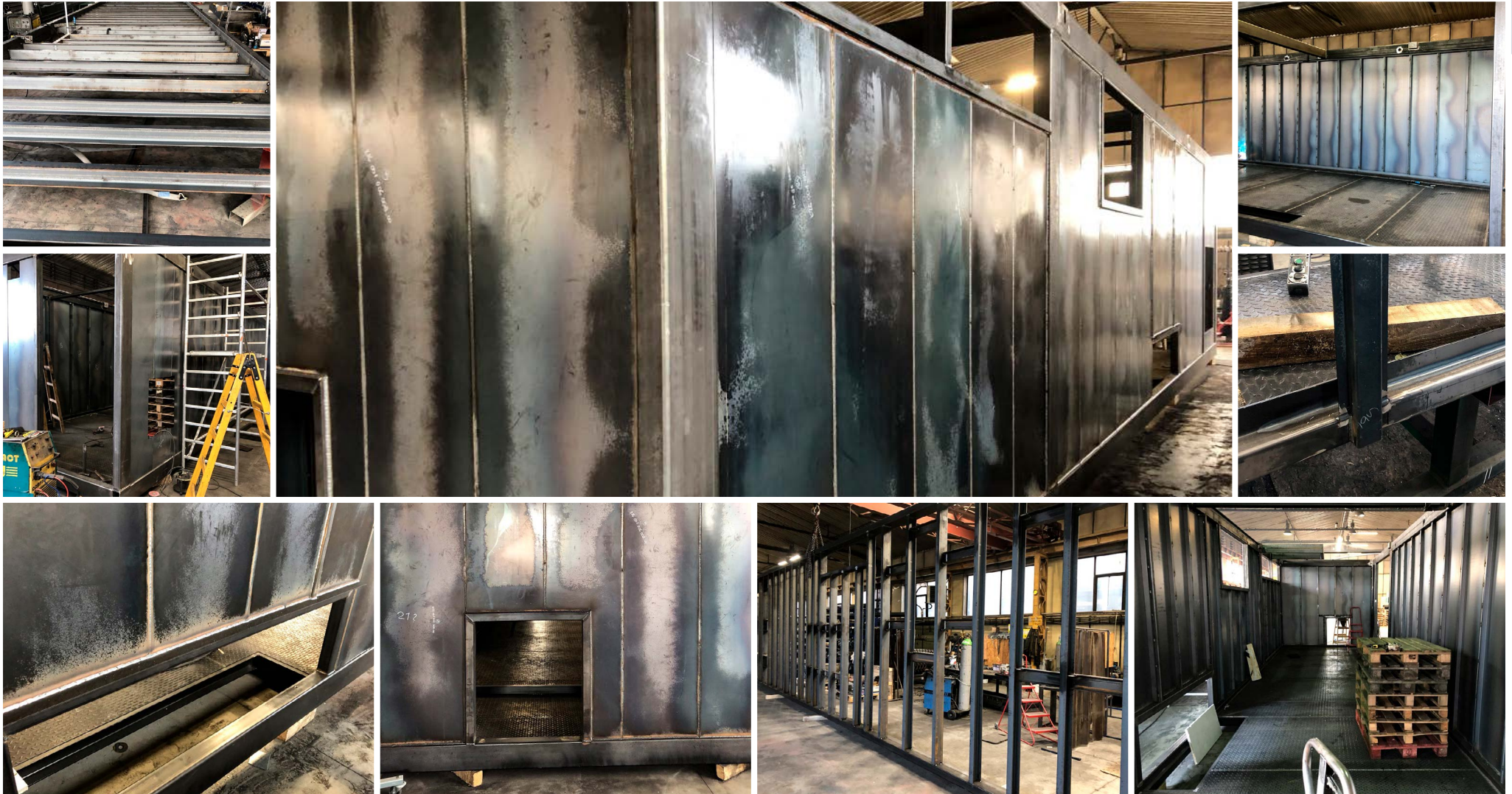

3,2 x 3 x 13,5 m SMART MAGNUM CABIN WITH SMART 500 kW BIOMASS BOILER, VISSMANN VITOPLEX 200 550 kW OIL BACK UP BOILER, ZEPPELIN CAT EL. GENERATOR 20 kW_e, 4000 l OF ACCUMULATION TANK STORAGE, 1 COMPLETELY CONTROLLED HEATING CIRCUIT, 2 x 18 m CHIMNEY, 2 X MULTI-FUEL CONVEYORS SET CONNECTED TO AN EXISTING CONCRETE SILO WITH MOVING SILO ROOF, NORWEGIAN ARMY BUILDINGS HEATING, NORDKISA-OSLO AIRPORT, NORWAY

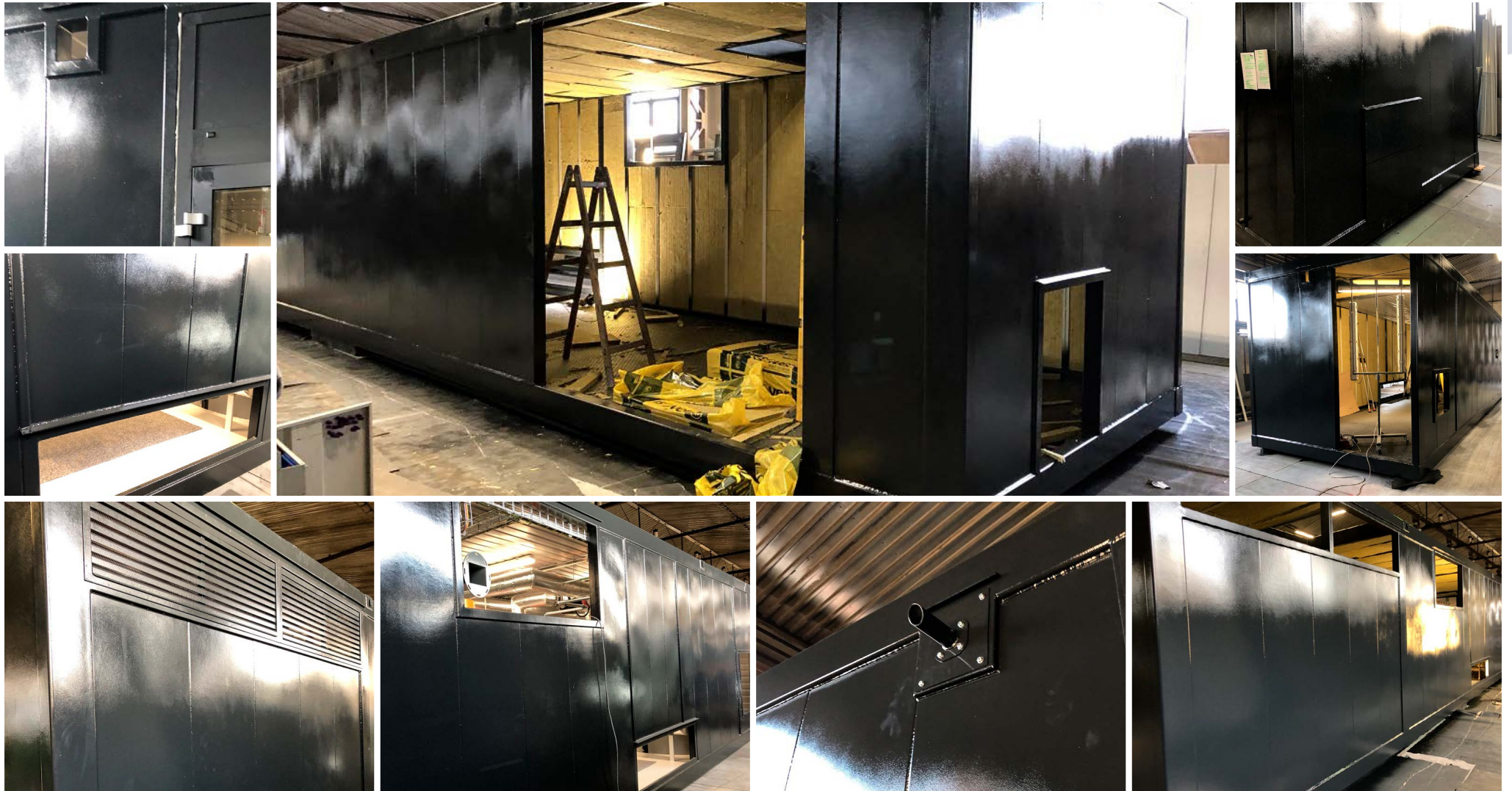

3,2 x 3 x 13,5 m SMART MAGNUM CABIN WITH SMART 500 kW BIOMASS BOILER, VISSMANN VITOPLEX 200 550 kW OIL BACK UP BOILER, ZEPPELIN CAT EL. GENERATOR 20 kW_e, 4000 l OF ACCUMULATION TANK STORAGE, 1 COMPLETELY CONTROLLED HEATING CIRCUIT, 2 x 18 m CHIMNEY, 2 X MULTI-FUEL CONVEYORS SET CONNECTED TO AN EXISTING CONCRETE SILO WITH MOVING SILO ROOF, NORWEGIAN ARMY BUILDINGS HEATING, NORDKISA-OSLO AIRPORT, NORWAY

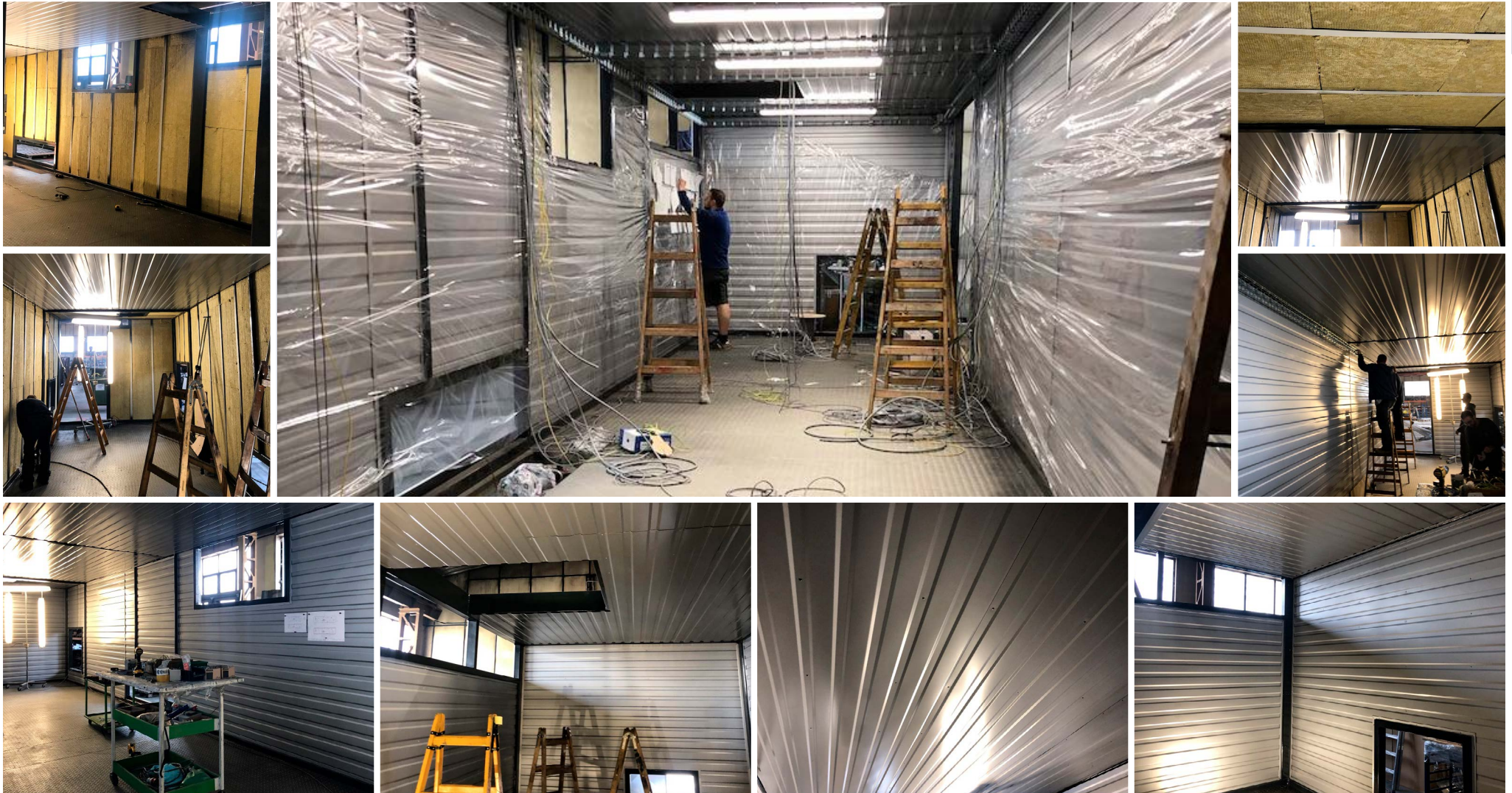

3,2 x 3 x 13,5 m SMART MAGNUM CABIN WITH SMART 500 kW BIOMASS BOILER, VISSMANN VITOPLEX 200 550 kW OIL BACK UP BOILER, ZEPPELIN CAT EL. GENERATOR 20 kW_e, 4000 l OF ACCUMULATION TANK STORAGE, 1 COMPLETELY CONTROLLED HEATING CIRCUIT, 2 x 18 m CHIMNEY, 2 X MULTI-FUEL CONVEYORS SET CONNECTED TO AN EXISTING CONCRETE SILO WITH MOVING SILO ROOF, NORWEGIAN ARMY BUILDINGS HEATING, NORDKISA-OSLO AIRPORT, NORWAY



3,2 x 3 x 13,5 m SMART MAGNUM CABIN WITH SMART 500 kW BIOMASS BOILER, VISSMANN VITOPLEX 200 550 kW OIL BACK UP BOILER, ZEPPELIN CAT EL. GENERATOR 20 kW_e, 4000 l OF ACCUMULATION TANK STORAGE, 1 COMPLETELY CONTROLLED HEATING CIRCUIT, 2 x 18 m CHIMNEY, 2 X MULTI-FUEL CONVEYORS SET CONNECTED TO AN EXISTING CONCRETE SILO WITH MOVING SILO ROOF, NORWEGIAN ARMY BUILDINGS HEATING, NORDKISA-OSLO AIRPORT, NORWAY



3,2 x 3 x 13,5 m SMART MAGNUM CABIN WITH SMART 500 kW BIOMASS BOILER, VISSMANN VITOPLEX 200 550 kW OIL BACK UP BOILER, ZEPPELIN CAT EL. GENERATOR 20 kW_e, 4000 l OF ACCUMULATION TANK STORAGE, 1 COMPLETELY CONTROLLED HEATING CIRCUIT, 2 x 18 m CHIMNEY, 2 X MULTI-FUEL CONVEYORS SET CONNECTED TO AN EXISTING CONCRETE SILO WITH MOVING SILO ROOF, NORWEGIAN ARMY BUILDINGS HEATING, NORDKISA-OSLO AIRPORT, NORWAY



3,2 x 3 x 13,5 m SMART MAGNUM CABIN WITH SMART 500 kW BIOMASS BOILER, VISSMANN VITOPLEX 200 550 kW OIL BACK UP BOILER, ZEPPELIN CAT EL. GENERATOR 20 kW_e, 4000 l OF ACCUMULATION TANK STORAGE, 1 COMPLETELY CONTROLLED HEATING CIRCUIT, 2 x 18 m CHIMNEY, 2 X MULTI-FUEL CONVEYORS SET CONNECTED TO AN EXISTING CONCRETE SILO WITH MOVING SILO ROOF, NORWEGIAN ARMY BUILDINGS HEATING, NORDKISA-OSLO AIRPORT, NORWAY



3,2 x 3 x 13,5 m SMART MAGNUM CABIN WITH SMART 500 kW BIOMASS BOILER, VISSMANN VITOPLEX 200 550 kW OIL BACK UP BOILER, ZEPPELIN CAT EL. GENERATOR 20 kW_e, 4000 l OF ACCUMULATION TANK STORAGE, 1 COMPLETELY CONTROLLED HEATING CIRCUIT, 2 x 18 m CHIMNEY, 2 X MULTI-FUEL CONVEYORS SET CONNECTED TO AN EXISTING CONCRETE SILO WITH MOVING SILO ROOF, NORWEGIAN ARMY BUILDINGS HEATING, NORDKISA-OSLO AIRPORT, NORWAY



3,2 x 3 x 13,5 m SMART MAGNUM CABIN WITH SMART 500 kW BIOMASS BOILER, VISSMANN VITOPLEX 200 550 kW OIL BACK UP BOILER, ZEPPELIN CAT EL. GENERATOR 20 kW_e, 4000 l OF ACCUMULATION TANK STORAGE, 1 COMPLETELY CONTROLLED HEATING CIRCUIT, 2 x 18 m CHIMNEY, 2 X MULTI-FUEL CONVEYORS SET CONNECTED TO AN EXISTING CONCRETE SILO WITH MOVING SILO ROOF, NORWEGIAN ARMY BUILDINGS HEATING, NORDKISA-OSLO AIRPORT, NORWAY



3,2 x 3 x 13,5 m SMART MAGNUM CABIN WITH SMART 500 kW BIOMASS BOILER, VISSMANN VITOPLEX 200 550 kW OIL BACK UP BOILER, ZEPPELIN CAT EL. GENERATOR 20 kW_e, 4000 l OF ACCUMULATION TANK STORAGE, 1 COMPLETELY CONTROLLED HEATING CIRCUIT, 2 x 18 m CHIMNEY, 2 X MULTI-FUEL CONVEYORS SET CONNECTED TO AN EXISTING CONCRETE SILO WITH MOVING SILO ROOF, NORWEGIAN ARMY BUILDINGS HEATING, NORDKISA-OSLO AIRPORT, NORWAY



3,2 x 3 x 13,5 m SMART MAGNUM CABIN WITH SMART 500 kW BIOMASS BOILER, VISSMANN VITOPLEX 200 550 kW OIL BACK UP BOILER, ZEPPELIN CAT EL. GENERATOR 20 kW_e, 4000 l OF ACCUMULATION TANK STORAGE, 1 COMPLETELY CONTROLLED HEATING CIRCUIT, 2 x 18 m CHIMNEY, 2 X MULTI-FUEL CONVEYORS SET CONNECTED TO AN EXISTING CONCRETE SILO WITH MOVING SILO ROOF, NORWEGIAN ARMY BUILDINGS HEATING, NORDKISA-OSLO AIRPORT, NORWAY



3,2 x 3 x 13,5 m SMART MAGNUM CABIN WITH SMART 500 kW BIOMASS BOILER, VISSMANN VITOPLEX 200 550 kW OIL BACK UP BOILER, ZEPPELIN CAT EL. GENERATOR 20 kW_e, 4000 l OF ACCUMULATION TANK STORAGE, 1 COMPLETELY CONTROLLED HEATING CIRCUIT, 2 x 18 m CHIMNEY, 2 X MULTI-FUEL CONVEYORS SET CONNECTED TO AN EXISTING CONCRETE SILO WITH MOVING SILO ROOF, NORWEGIAN ARMY BUILDINGS HEATING, NORDKISA-OSLO AIRPORT, NORWAY

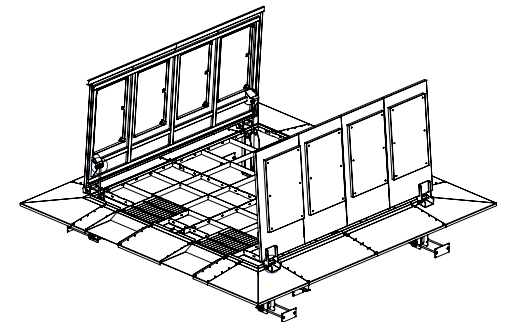
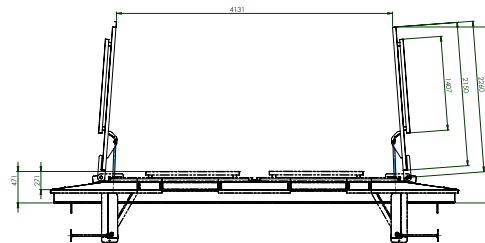
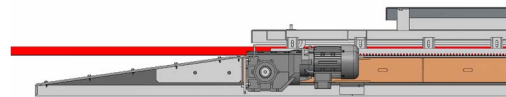
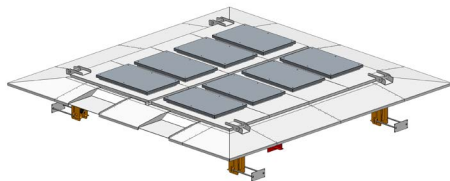
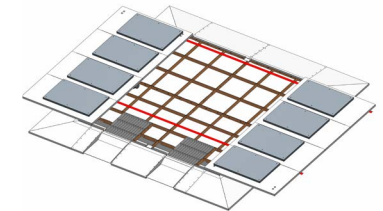
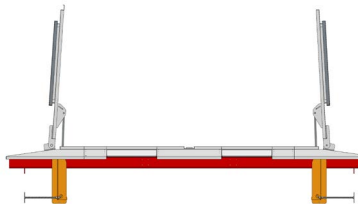
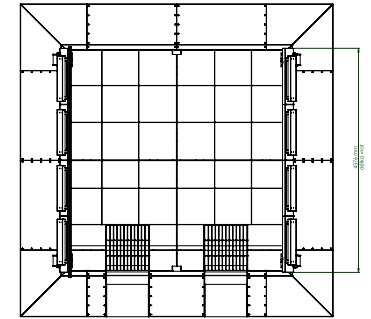
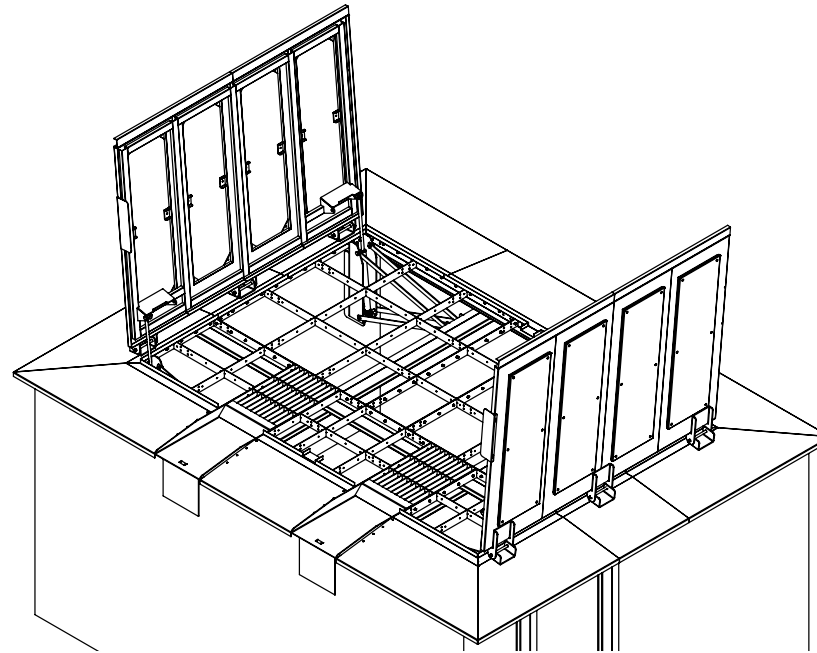
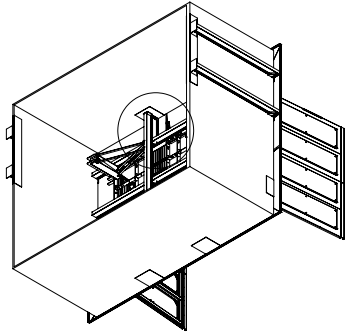

3,2 x 3 x 13,5 m SMART MAGNUM CABIN WITH SMART 500 kW BIOMASS BOILER, VISSMANN VITOPLEX 200 550 kW OIL BACK UP BOILER, ZEPPELIN CAT EL. GENERATOR 20 kW_e, 4000 l OF ACCUMULATION TANK STORAGE, 1 COMPLETELY CONTROLLED HEATING CIRCUIT, 2 x 18 m CHIMNEY, 2 X MULTI-FUEL CONVEYORS SET CONNECTED TO AN EXISTING CONCRETE SILO WITH MOVING SILO ROOF, NORWEGIAN ARMY BUILDINGS HEATING, NORDKISA-OSLO AIRPORT, NORWAY



3,2 x 3 x 13,5 m SMART MAGNUM CABIN WITH SMART 500 kW BIOMASS BOILER, VISSMANN VITOPLEX 200 550 kW OIL BACK UP BOILER, ZEPPELIN CAT EL. GENERATOR 20 kW_e, 4000 l OF ACCUMULATION TANK STORAGE, 1 COMPLETELY CONTROLLED HEATING CIRCUIT, 2 x 18 m CHIMNEY, 2 X MULTI-FUEL CONVEYORS SET CONNECTED TO AN EXISTING CONCRETE SILO WITH MOVING SILO ROOF, NORWEGIAN ARMY BUILDINGS HEATING, NORDKISA-OSLO AIRPORT, NORWAY

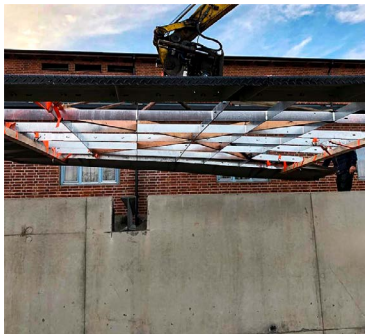

SMART REFERENCE LIST | SMART CABIN 500 KW

WOOD PELLETS SILO DESIGN WITH EMERGENCY ROOF FILLING OUTLETS
1 HEATING CIRCUIT – FULLY MONITORED AND CONTROLLED APARTMENT HOUSE
DUMFRIES, SCOTLAND

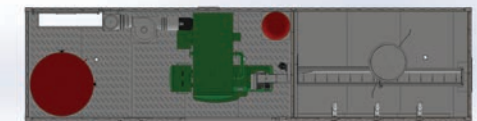
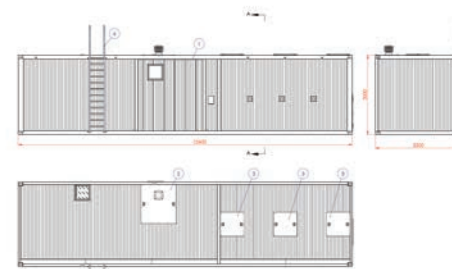
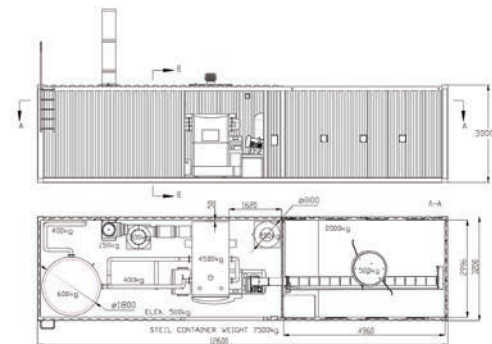
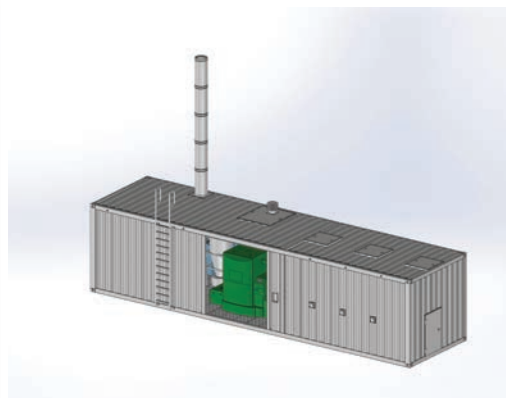
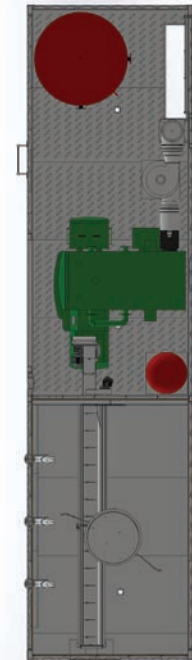
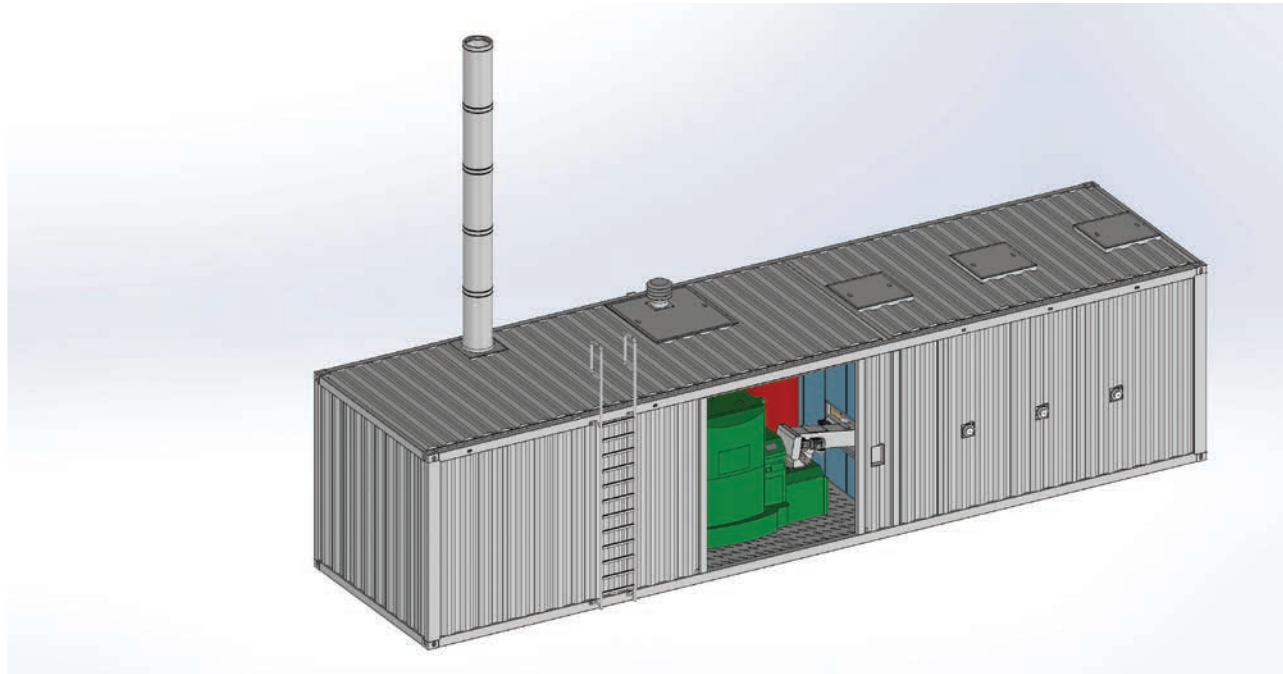
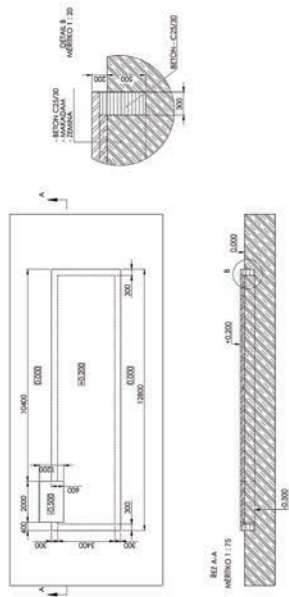

WOOD PELLETS SILO DESIGN WITH EMERGENCY ROOF FILLING OUTLETS
1 HEATING CIRCUIT – FULLY MONITORED AND CONTROLLED APARTMENT HOUSE
DUMFRIES, SCOTLAND



WOOD PELLETS SILO DESIGN WITH EMERGENCY ROOF FILLING OUTLETS
1 HEATING CIRCUIT – FULLY MONITORED AND CONTROLLED APARTMENT HOUSE
DUMFRIES, SCOTLAND





**SMART HEATING
TECHNOLOGY**

SMART HEATING TECHNOLOGY

SMART REFERENCE LIST | SMART CABIN 500 KW

WOOD PELLETS SILO DESIGN WITH EMERGENCY ROOF FILLING OUTLETS
1 HEATING CIRCUIT – FULLY MONITORED AND CONTROLLED APARTMENT HOUSE
DUMFRIES, SCOTLAND



SMART REFERENCE LIST | SMART MAGNUM CABIN WITH BIOMASS-OIL COMBINATION 350 KW + 550 KW

3,2 X 3 X 13,8 M SMART MAGNUM CABIN WITH 2 X 4000 L OF ACCUMULATION TANK STORAGE, 1+1 HEATING CIRCUIT, 2 X 12 M CHIMNEY + CHIMNEY STRUCTURE, MULTI-FUEL CONVEYOR CONNECTED TO AN EXISTING SILO WITH MOVING FLOOR
SCHOOL HEATING + APARTMENT BUILDING HEATING, LILLEHAMMER, NORWAY

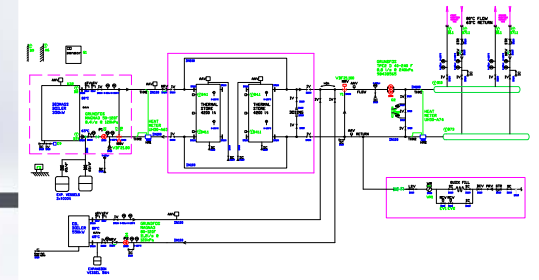
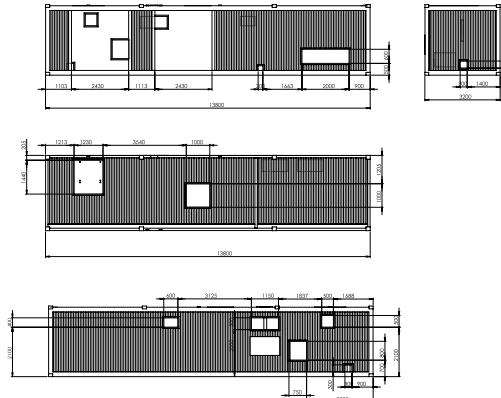
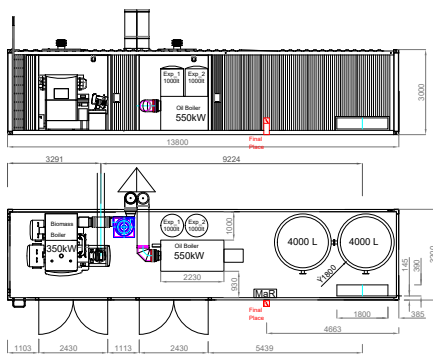
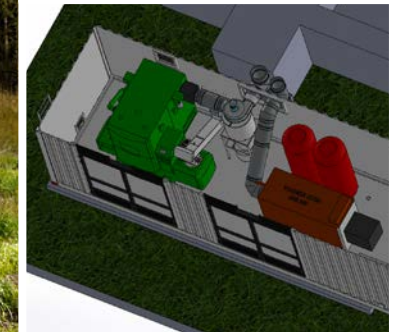
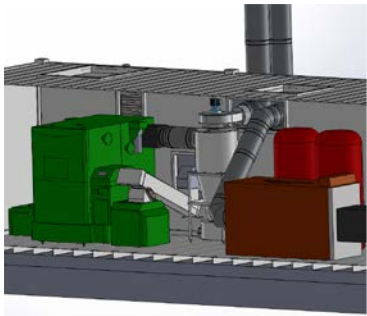
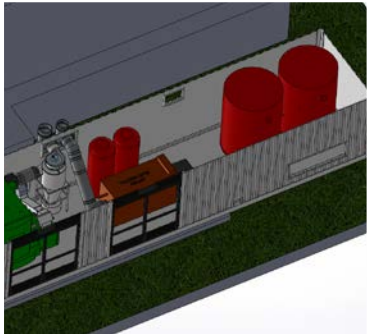



SMART REFERENCE LIST | SMART MAGNUM CABIN WITH BIOMASS-OIL COMBINATION 350 KW + 550 KW

3,2 X 3 X 13,8 M SMART MAGNUM CABIN WITH 2 X 4000 L OF ACCUMULATION TANK STORAGE, 1+1 HEATING CIRCUIT, 2 X 12 M CHIMNEY + CHIMNEY STRUCTURE, MULTI-FUEL CONVEYOR CONNECTED TO AN EXISTING SILO WITH MOVING FLOOR
SCHOOL HEATING + APARTMENT BUILDING HEATING, LILLEHAMMER, NORWAY

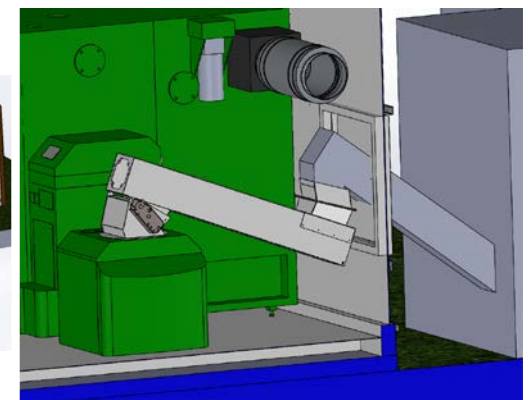
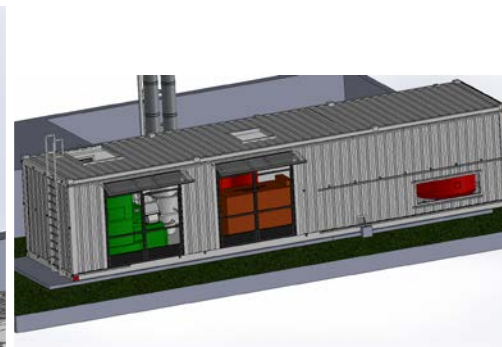
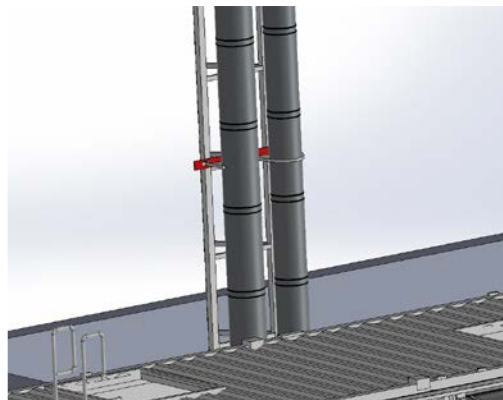
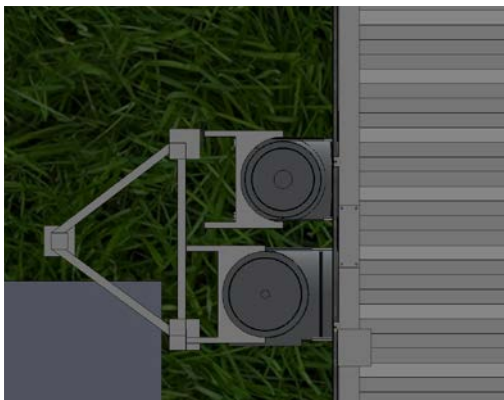
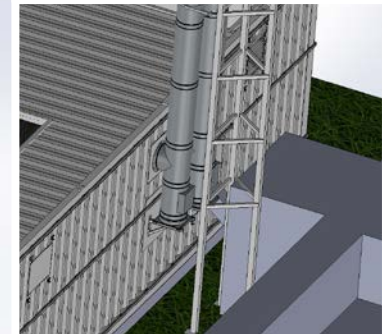
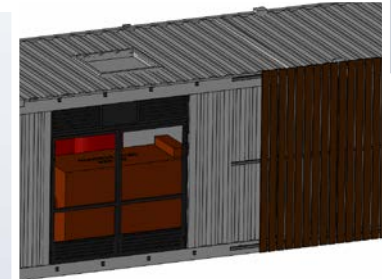
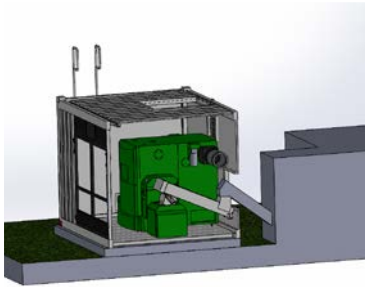



SMART HEATING TECHNOLOGY

SMART HEATING TECHNOLOGY

SMART REFERENCE LIST | SMART MAGNUM CABIN WITH BIOMASS-OIL COMBINATION 350 KW + 550 KW

3,2 X 3 X 13,8 M SMART MAGNUM CABIN WITH 2 X 4000 L OF ACCUMULATION TANK STORAGE, 1+1 HEATING CIRCUIT, 2 X 12 M CHIMNEY + CHIMNEY STRUCTURE, MULTI-FUEL CONVEYOR CONNECTED TO AN EXISTING SILO WITH MOVING FLOOR SCHOOL HEATING + APARTMENT BUILDING HEATING, LILLEHAMMER, NORWAY



SMART REFERENCE LIST | SMART MAGNUM CABIN WITH BIOMASS-OIL COMBINATION 350 KW + 550 KW

3,2 X 3 X 13,8 M SMART MAGNUM CABIN WITH 2 X 4000 L OF ACCUMULATION TANK STORAGE, 1+1 HEATING CIRCUIT, 2 X 12 M CHIMNEY + CHIMNEY STRUCTURE, MULTI-FUEL CONVEYOR CONNECTED TO AN EXISTING SILO WITH MOVING FLOOR
SCHOOL HEATING + APARTMENT BUILDING HEATING, LILLEHAMMER, NORWAY



SMART REFERENCE LIST | SMART MAGNUM CABIN WITH BIOMASS-OIL COMBINATION 350 KW + 550 KW

3,2 X 3 X 13,8 M SMART MAGNUM CABIN WITH 2 X 4000 L OF ACCUMULATION TANK STORAGE, 1+1 HEATING CIRCUIT, 2 X 12 M CHIMNEY + CHIMNEY STRUCTURE, MULTI-FUEL CONVEYOR CONNECTED TO AN EXISTING SILO WITH MOVING FLOOR SCHOOL HEATING + APARTMENT BUILDING HEATING, LILLEHAMMER, NORWAY



SMART REFERENCE LIST | SMART MAGNUM CABIN WITH BIOMASS-OIL COMBINATION 350 KW + 550 KW

3,2 X 3 X 13,8 M SMART MAGNUM CABIN WITH 2 X 4000 L OF ACCUMULATION TANK STORAGE, 1+1 HEATING CIRCUIT, 2 X 12 M CHIMNEY + CHIMNEY STRUCTURE, MULTI-FUEL CONVEYOR CONNECTED TO AN EXISTING SILO WITH MOVING FLOOR SCHOOL HEATING + APARTMENT BUILDING HEATING, LILLEHAMMER, NORWAY





SMART HEATING TECHNOLOGY

SMART HEATING TECHNOLOGY

SMART REFERENCE LIST | SMART MAGNUM CABIN WITH BIOMASS-OIL COMBINATION 350 KW + 550 KW

3,2 X 3 X 13,8 M SMART MAGNUM CABIN WITH 2 X 4000 L OF ACCUMULATION TANK STORAGE, 1+1 HEATING CIRCUIT, 2 X 12 M CHIMNEY + CHIMNEY STRUCTURE, MULTI-FUEL CONVEYOR CONNECTED TO AN EXISTING SILO WITH MOVING FLOOR
SCHOOL HEATING + APARTMENT BUILDING HEATING, LILLEHAMMER, NORWAY





SMART HEATING TECHNOLOGY

SMART HEATING TECHNOLOGY

SMART REFERENCE LIST | SMART MAGNUM CABIN WITH BIOMASS-OIL COMBINATION 350 KW + 550 KW

3,2 X 3 X 13,8 M SMART MAGNUM CABIN WITH 2 X 4000 L OF ACCUMULATION TANK STORAGE, 1+1 HEATING CIRCUIT, 2 X 12 M CHIMNEY + CHIMNEY STRUCTURE, MULTI-FUEL CONVEYOR CONNECTED TO AN EXISTING SILO WITH MOVING FLOOR
SCHOOL HEATING + APARTMENT BUILDING HEATING, LILLEHAMMER, NORWAY



SMART REFERENCE LIST | SMART MAGNUM CABIN WITH BIOMASS-OIL COMBINATION 350 KW + 550 KW

3,2 X 3 X 13,8 M SMART MAGNUM CABIN WITH 2 X 4000 L OF ACCUMULATION TANK STORAGE, 1+1 HEATING CIRCUIT, 2 X 12 M CHIMNEY + CHIMNEY STRUCTURE, MULTI-FUEL CONVEYOR CONNECTED TO AN EXISTING SILO WITH MOVING FLOOR
SCHOOL HEATING + APARTMENT BUILDING HEATING, LILLEHAMMER, NORWAY

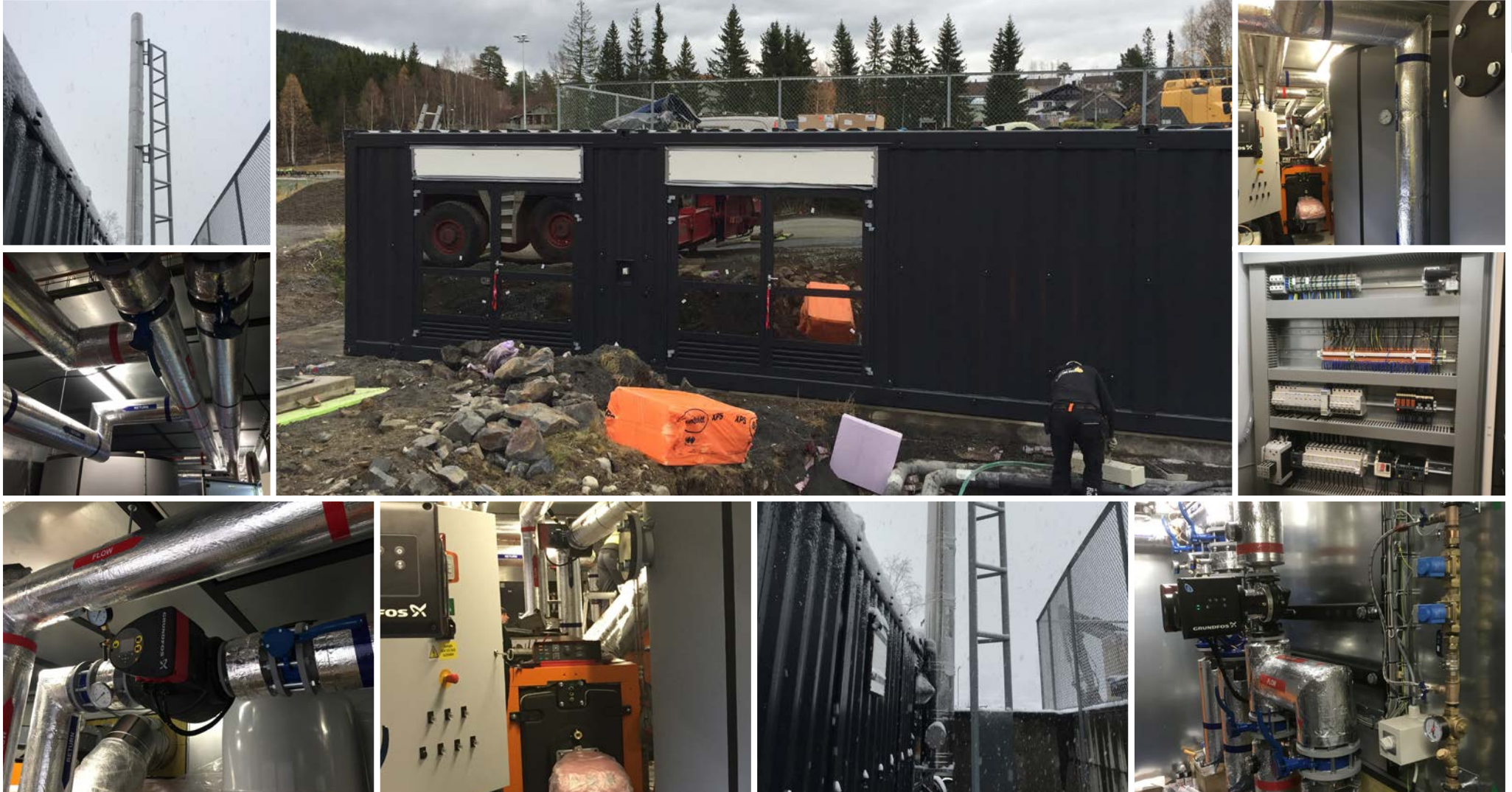



SMART HEATING TECHNOLOGY

SMART HEATING TECHNOLOGY

SMART REFERENCE LIST | SMART MAGNUM CABIN WITH BIOMASS-OIL COMBINATION 350 KW + 550 KW

3,2 X 3 X 13,8 M SMART MAGNUM CABIN WITH 2 X 4000 L OF ACCUMULATION TANK STORAGE, 1+1 HEATING CIRCUIT, 2 X 12 M CHIMNEY + CHIMNEY STRUCTURE, MULTI-FUEL CONVEYOR CONNECTED TO AN EXISTING SILO WITH MOVING FLOOR
SCHOOL HEATING + APARTMENT BUILDING HEATING, LILLEHAMMER, NORWAY



SMART REFERENCE LIST | SMART MAGNUM CABIN WITH BIOMASS-OIL COMBINATION 350 KW + 550 KW

3,2 X 3 X 13,8 M SMART MAGNUM CABIN WITH 2 X 4000 L OF ACCUMULATION TANK STORAGE, 1+1 HEATING CIRCUIT, 2 X 12 M CHIMNEY + CHIMNEY STRUCTURE, MULTI-FUEL CONVEYOR CONNECTED TO AN EXISTING SILO WITH MOVING FLOOR
SCHOOL HEATING + APARTMENT BUILDING HEATING, LILLEHAMMER, NORWAY

